

## **STUDY ON EARTHQUAKE RESPONSE CHARACTERISTICS OF BASE-ISOLATED BUILDING USING THE FRICTION DAMPERS WITH CONED DISC SPRINGS**

**Nakamura TAKASHI<sup>1</sup>, Suzuki TETSUO<sup>2</sup>, Nobata ARIHIDE<sup>2</sup>, Suwa HITOSHI<sup>2</sup> And Inaba SATORU<sup>2</sup>**

### **SUMMARY**

This report describes the static and dynamic characteristics of base-isolated building using friction dampers with coned disc springs and laminated natural rubber bearings. The friction damper uses coned disc springs to press down a sliding material vertically against a stainless steel plate installed on the foundation horizontally. When the friction damper is moved horizontally by earthquake or gale, then friction occurs between the sliding material and stainless steel plate, and vibration energy is absorbed. The present coned disc springs are designed to obtain non-linear characteristics, which always springs up a constant resilient force, without being affected by the height variations of the laminated rubber bearings. Static and shaking table tests of base-isolation model using the friction dampers and laminated rubber bearings were taken into practice to grasp basic characteristics and functions of the friction damper. From the results of tests and analyses, the following functions of the friction damper in base-isolation system were confirmed. (1) The friction damper with coned disc springs resists the horizontal load of gale and restrains base-isolation system to prevent the aggravation of dwelling ability by shake. (2) The friction damper has such a stable damping efficiency without undergoing influence by height fluctuations of the laminated rubber bearing caused by daily temperature expansion and contraction, creep and the rocking vibration in case of the earthquake. (3) The friction damper has a function of supporting load and securing the base-isolation system against emergent excessive earthquake input. The example of the friction damper with coned disc springs applied in the actual base-isolated building is presented in the end.

### **INTRODUCTION**

The friction damper with coned disc springs was developed as a partner with laminated natural rubber bearing for base-isolation system. In this paper, the mechanism of this friction damper is described at first. Next, the static and shaking table tests and simulation analyses of base-isolated building model using the friction dampers with coned disc springs and laminated natural rubber bearings are mentioned. After that, the dynamic characteristics and functions of this friction damper are reported. Finally, the example of the friction damper with coned disc springs applied in the actual base-isolated building is presented.

## **2. MECHANISM OF THE FRICTION DAMPER WITH CONED DISC SPRINGS**

The temperature and the creep phenomenon change the height of laminated rubber bearing. Also, in case of the earthquake, the height of laminated rubber bearing becomes lower with increase of the horizontal deformation. To sum up all quantity of these height fluctuations each other, it is possible to estimate the amount of height variation for 60 years of laminated rubber bearing applied for base-isolated buildings to be about 10 mm. As for

<sup>1</sup> Consulting Department, Engineering Division, Obayashi Corporation, Tokyo, Japan, E-mail: takachan@pub.obayashi.co.jp

<sup>2</sup> Structural Engineering Department, Technical Research Institute, Obayashi Corporation

friction damper for base-isolation systems, the function to secure the stable efficiency without undergoing influence of these height fluctuations of laminated rubber bearing is required. The principle of the friction damper with coned disc springs is shown in Figure 1. This friction damper generates friction by pressing down the plate of ultra high molecular weight polyethylene (UHMWP) as the sliding material against the installed stainless steel plate on the foundation horizontally by the vertical resilient force of coned disc springs. To prevent slide sideways the multiples coned disc springs arranged in series and parallel and to transmit the frictional force to the superstructure, a cylindrical guide is set inside of multiple coned disc springs (see Figure 9). If the resilient force of coned disc springs and the frictional coefficient of the sliding material are constant, the frictional force becomes constant, too. The load-deflection curve in which the resilient force is nearly constant can be obtained by the special shape of coned disc spring.

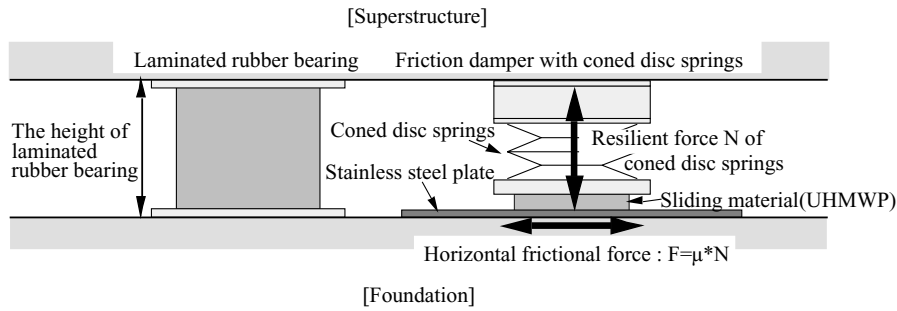
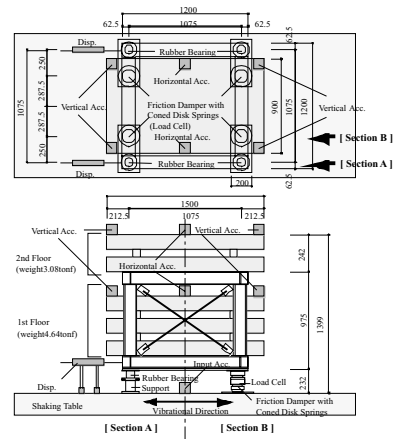

Figure 1. Principle of the friction damper with coned disc springs

### 3. SHAKING TABLE TESTS FOR THE BASE-ISOLATED MODEL



Photo of shaking table test model



Outline of Shaking table test model

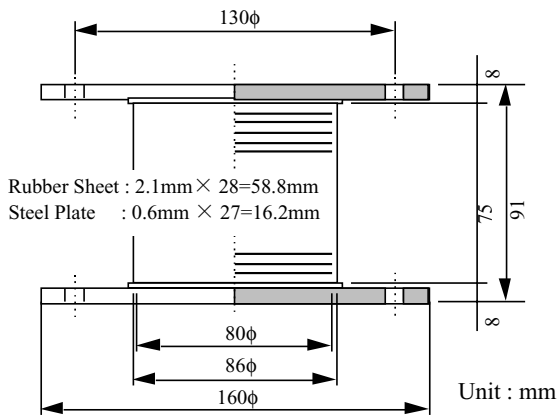

Outline of the laminated natural rubber bearing

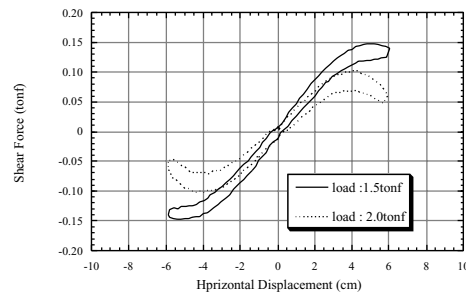

Horizontal load-deflection curves of rubber bearing

**Figure 3. The laminated natural rubber bearing for shaking table test model**

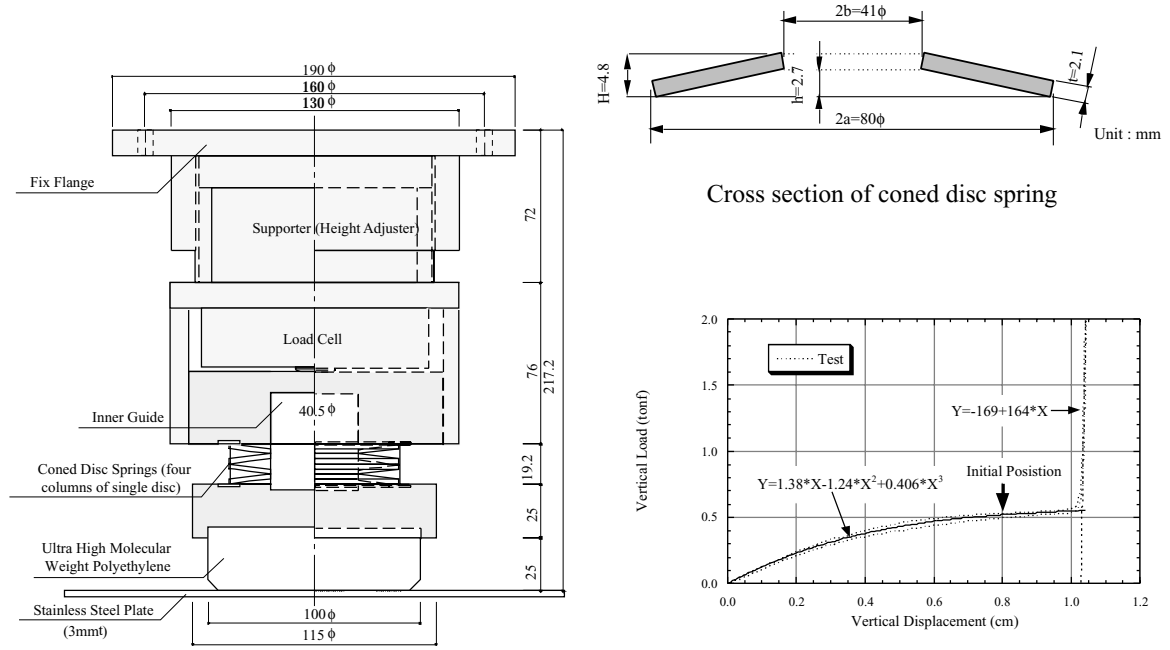

Outline of the friction damper with coned disc springs      Vertical load-deflection curves of the friction damper

**Figure 4. The friction damper with coned disc springs for shaking table test model**

The photo and outline of shaking table test model of base-isolation building are shown in Figure 2. The superstructure of the base-isolated model is a single-story steel-frame, having the first floor of 4.64ton and roof floor of 3.08ton, then a total weight is about 8ton. The base-isolation devices are composed of four pairs of laminated natural rubber bearing and friction damper with coned disc springs in parallel.

The outline of the laminated natural rubber bearing and its horizontal hysteresis characteristic in the condition of supporting the load of 1.5ton and 2ton are shown in figure 3. For the shape of this laminated rubber bearing is slender, the horizontal stiffness is roughly linear in the region of horizontal displacement of  $\pm 2$ cm. The horizontal stiffness becomes gradually weak in proportion to the increase of horizontal displacement, and there is risk of buckling at the horizontal displacements of  $\pm 4$ cm in the condition of supporting load of 2ton and at that of  $\pm 5$ cm under supporting load of 1.5ton. If we support the superstructure with only four pieces of this laminated rubber bearing, the supporting load of each laminated rubber bearing becomes 2ton, then there is risk of buckling in laminated rubber bearing more than  $\pm 4$ cm of horizontal displacements. As for this shaking table model, each friction damper supports the long time loading of about 0.5 ton and each laminated rubber bearing supports that of about 1.5 ton.

The outline of the friction damper with coned disc springs and its load-deflection curve in the vertical direction are shown in figure 4. The material of the coned disc spring is SUP10 and the size of outside diameter is 80mm, inside diameter is 41mm, the free height ( $h$ ) is 2.7mm, and thickness ( $t$ ) is 2.1mm. The load-deflection curve in which the load is nearly constant is obtained when  $h$  is of the order of  $t\sqrt{2}$  in coned disc spring. The friction damper uses 4 sheets of coned disc springs top and bottom in series. To measure the supporting load, load cell is contained in the friction damper. The friction damper with coned disc springs shows a non-linear load-deflection curve, and generates the constant resilient force of 0.5ton approximately between the deflection of 0.7cm and 0.9cm. Then, the coned disc springs become flat at the deflection of 1.03cm and can support heavier load. When excluding the load on the friction damper, the coned disc springs return to the original condition perfectly. The deflection of coned disc springs in the friction damper is set at 0.8cm, then its resilient force becomes 0.5ton. The friction damper generates friction by pressing down the sliding material of UHMWP against the installed stainless steel plate on the foundation horizontally by the vertical resilient force of coned disc springs. The frictional coefficient of the sliding material is about 0.15, so the frictional force is approximately 0.075ton. The horizontal hysteresis characteristic models of the base-isolation devices are shown in figure 5. As for the base-isolation devices of this shaking table test model, each friction damper supports the long time loading of about 0.5ton and each laminated rubber bearing supports that of about 1.5ton.

### 3.1 Static Load Test of the Base-isolated Model

Static tests with the jacks and simulation analyses were performed to investigate the basic characteristics of the base-isolated building model on the shaking table. Figure 5 shows the analytical model for shaking table test model and horizontal hysteresis characteristics of base-isolation devices. The horizontal hysteresis loops and the vertical displacement of the base-isolation system, and the supporting load of the friction dampers by the static tests and simulation analyses are shown in figure 5, too.

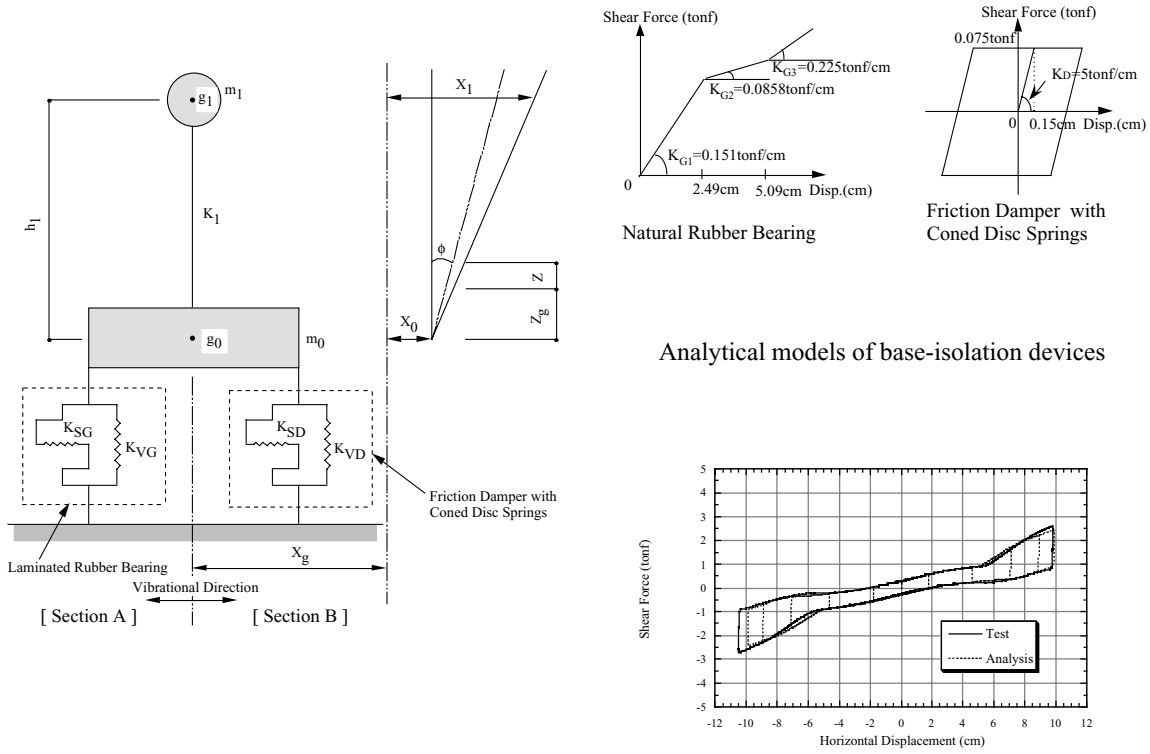

Analytical model for shaking table test model

Hysteresis loop of the base-isolation system (Static)

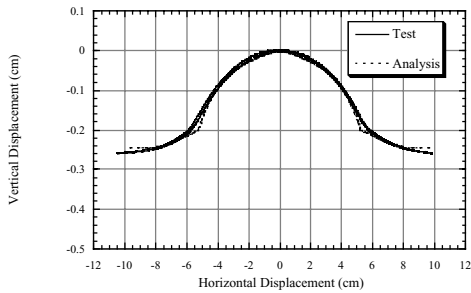

Vertical displacement of rubber bearings (Static)

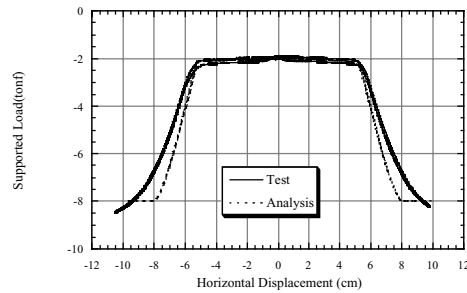

Total supporting load of the friction dampers (Static)

**Figure 5. Analytical model for shaking table test and static test results**

As for the horizontal hysteresis characteristic of the model, the horizontal stiffness of rubber bearing is linear in the region of horizontal displacement of  $\pm 2\text{cm}$ , and with frictional force of the friction damper, the hysteresis characteristic shows the hysteresis loop of perfect elasto-plasticity. The frictional force shows nearly constant 0.3ton in the region of horizontal displacement  $\pm 2\text{cm}$  to  $\pm 5\text{cm}$  where the total resilient force of the coned disc springs is approximately constant 2ton. The friction damper supports the load of equivalent to the resilient force by the contained coned disc springs, then the supporting load of the laminated rubber bearing is reduced.

The vertical displacement of the laminated rubber bearing becomes nearly 0.2cm at  $\pm 5$ cm of horizontal displacement, and the coned disc spring becomes flat condition, then the weight of superstructure gradually shifts onto the friction dampers and friction force increases.

The total weight 8ton of the superstructure is supported by the friction dampers at  $\pm 9$ cm that is larger than the diameter of the rubber bearing, and the vertical displacement becomes to be convergent. The friction damper prevents buckling of rubber bearing in excessive deformation and it controls displacement of base-isolation system. The superstructure is restored to its original position by the restoring force of rubber bearings, even after excessive deformation. The analytical values shown with broken lines in figure 5 agree well with the test results.

### 3.2 Shaking Table Test of the Base-isolated Model

The shaking table test results of sine wave input are presented in this paper. Sine wave in the period of 0.8second and acceleration increases gradually to maximum 250gal is inputted to the base-isolation building model on the shaking table in horizontal direction. The measured waveforms of input acceleration, displacement of the base-isolation system and the response acceleration of the superstructure are shown in Figure 6.

The horizontal displacement of the base-isolation devices comes up to approximately 8cm, that is nearly equal to the diameter of the laminated rubber bearing. The displacement of the base-isolation system doesn't occur under about 70gal input. This is because the frictional force of the friction damper with coned disc springs is bigger than the horizontal force by the earthquake, then the friction damper functions as the trigger which restrains base-isolation system from sliding by gales. The response acceleration of superstructure is nearly confined within 500gal.

The relation of the horizontal displacement and the shearing force of the product of the response acceleration and the weight of the superstructure is shown in hysteresis loop of the base-isolation system in figure 7. The characteristic of the vertical displacement of the laminated rubber bearings and the supporting load of the friction damper is shown in figure 7, too.

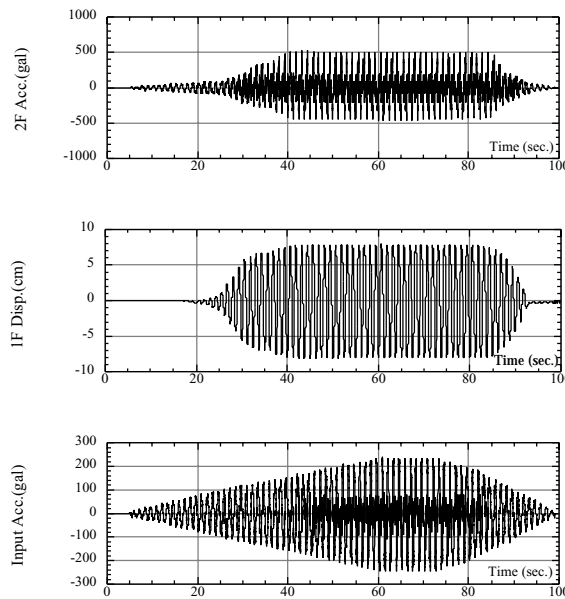
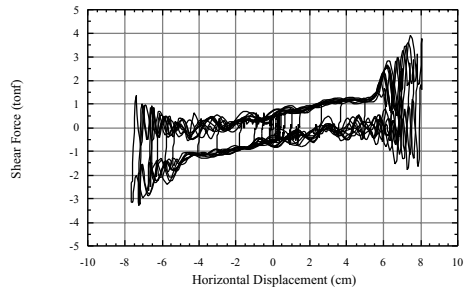
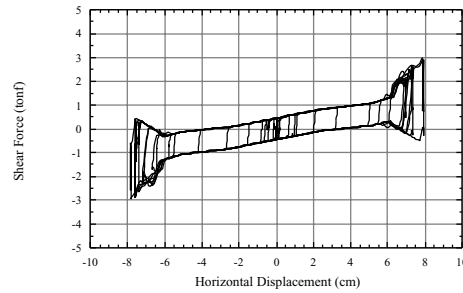

Figure 6. Waveforms of shaking table test of sine wave input



Hysteresis loop of the base-isolation system (Test)



Hysteresis loop of the base-isolation system (Analysis)

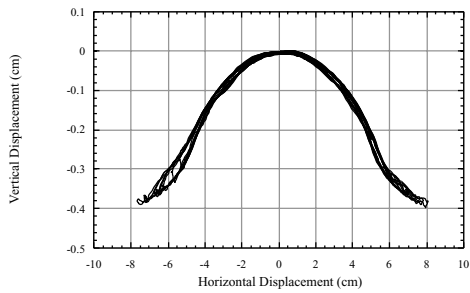

Vertical displacement of rubber bearings (Test)

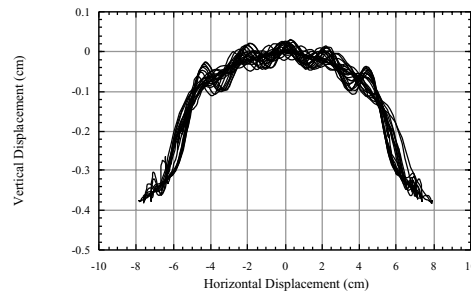

Vertical displacement of rubber bearings (Analysis)

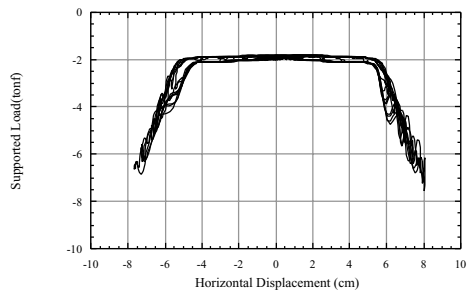

Total supporting load of the friction dampers (Test)

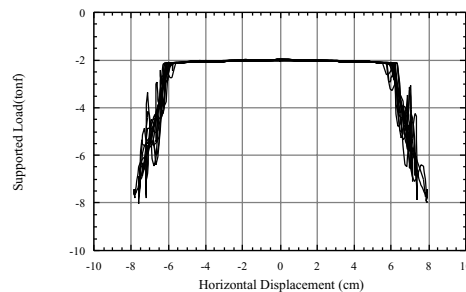

Total supporting load of the friction dampers (Analysis)

**Figure 7. Shaking table test (Sine wave input)**

In figure 7, total supporting load of the friction dampers is constant about 2ton in the region of horizontal displacement of  $\pm 5\text{cm}$ , and the vertical displacement of laminated rubber bearings is in the region of  $0\text{cm}$  to  $-0.2\text{cm}$ . This is because the coned disc springs generate constant resilient force and the fluctuation of load by the rocking vibration doesn't have the influence on the friction damper with the coned disc springs. The coned disc springs becomes a flat condition in equal or more than horizontal displacement of  $\pm 5\text{cm}$ , and as the horizontal displacement increases, the supporting load increases. The fluctuation by rocking vibration is seen in the supporting load of the friction damper. As supporting load is shifts to the friction damper with coned disc springs, the frictional force increases in the horizontal hysteresis loop of the base-isolation system. The result of the earthquake response analysis of the sine wave input is shown in figure 7, too. The vertical displacement of

the base-isolation devices by the analysis shows the influence of the fluctuation of the supporting load of the laminated rubber bearing by the rocking vibration. The hysteresis loop of the base-isolation system, the vertical displacement of the base-isolation devices and total supporting load of the friction dampers of the earthquake response analysis shows good agreement with the shaking table test.

**4. EXAMPLE OF THE FRICTION DAMPER WITH CONED DISC SPRINGS APPLIED IN ACTUAL BASE-ISOLATION BUILDING**

The photo of the friction damper with coned disc springs applied in the actual base-isolation building is shown in Figure 8 and outline is shown in Figure 9. This friction dampers with coned disc springs are used to resist the horizontal load of gale by the setting of frictional force and restrain base-isolation system to prevent the aggravation of dwelling ability by shaking of the building. The material of the coned disc spring is SUP10 and the size of outside diameter is 420mm, inside diameter is 190mm, the free height (h) is 14.7mm, and thickness (t) is 10.6mm. The constant resilient force of this coned disc spring is about 123kN. In this damper, four sets of double coned disc springs are combined in series.

The vertical load-deflection curves and horizontal hysteresis loop by the dynamic test of the friction damper is shown in Figure 10. In the vertical-deflection curves, the resilient force of this friction damper becomes twice and deflection stroke becomes about four times compare with those of a single coned disc spring. The vertical load-deflection curves by analyses show good agreement with the results of static vertical load test. In this friction damper, vertical deflection of the coned disc springs is used in the region of 35mm to 45, and the resilient force of friction damper is about 250kN. As the friction coefficient of sliding material is nearly 0.2, then the friction force of horizontal hysteresis loop by the dynamic test is about 50kN.



**Figure 8. Photo of the friction damper with the coned disc springs in the actual base-isolation building**

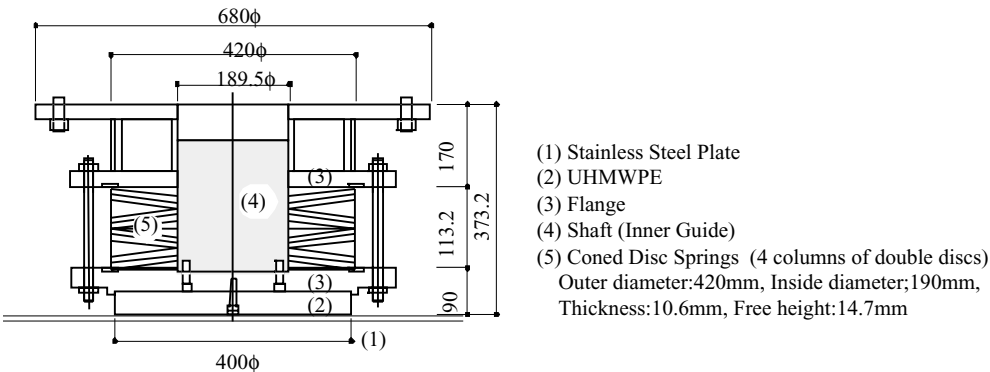

**Figure 9. Outline of the friction damper with the coned disc springs in the actual base-isolation building**

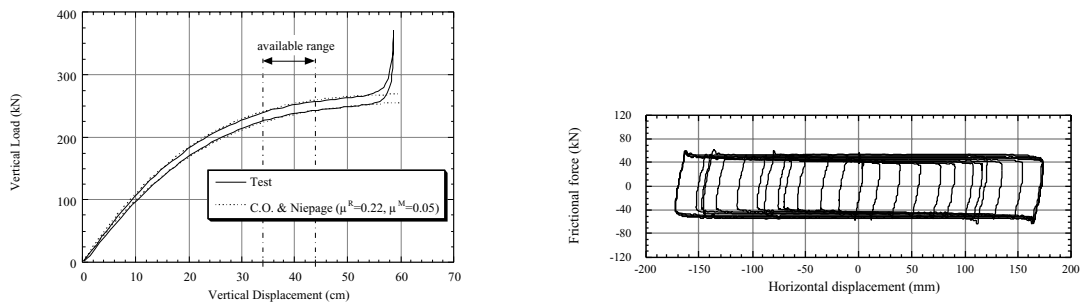

Vertical load-deflection curves of the friction damper      Horizontal hysteresis loops of the friction damper  
**Figure 10. Hysteresis characteristic of the actual friction damper with the coned disc springs**

## 5. CONCLUSIONS

It confirmed the following dynamic characteristic and numerous functions of the friction damper with coned disc springs by the shaking table test and the analysis of the base-isolated building model.

- 1) The friction damper with coned disc springs resists the horizontal load of gale by the setting of frictional force and restrains base-isolation system to prevent the aggravation of dwelling ability by shaking of the building.
- 2) The friction damper has such a stable damping with hysteretic characteristic of perfect elasto-plasticity without undergoing influence by height fluctuations of the laminated rubber bearing caused by daily temperature expansion and contraction, creep and the rocking vibration in case of the earthquake.
- 3) The friction damper supports the load of equivalent to the resilient force by the contained coned disc springs, then the supported load of the laminated rubber bearing is reduced. If we use more smaller size laminated rubber bearing with the friction damper, the total horizontal stiffness of the base-isolation system becomes small, and the base-isolation period becomes longer consequently and we can more improve the base-isolation efficiency.
- 4) When the large displacement occurs in the laminated rubber bearing by the excessive earthquake input and the subsidence becomes large, the friction damper supports the load of the laminated rubber bearing substitutionally as the safety device. As the weight of superstructure gradually shifts onto the friction damper, the frictional force gradually increases and the displacement of the base-isolation system can be controlled and safety is secured

## REFERENCES

1. Almen, J.O. and Laszlo, A. (1936) *The Uniform-Section Disk Spring*. Trans. ASME, 58, pp.305-314.
2. Curti, G. und Orland, M. (1979) *Ein neues Berechnungsverfahren für Tellerfedern*, DRAHT 30-1, pp.17-21.
3. Niepage, P. (1984) *Über den Einfluß der Reibung und keilförmiger Lasteinleitungselemente auf die Kennlinie von Einzeltellerfedern und Tellerfederpaketen*, Konstruktion, 36-10, pp.379-384.
4. Nakamura T., Suzuki T. and Inaba S. (1998) *An Experimental Study on the Restoring Force Characteristics of the Friction Damper with Coned Disc Springs for Base-isolation System*. Journal of Structural Engineering, AIJ, No.510, pp.75-82.
5. Nakamura T., Suzuki T. and Okada H. (1998) *Aging Characteristics of Natural Rubber Bearings in actual Base-isolated Building*. Journal of Architecture and Building Science, AIJ, Vol.113 No.1429, pp.23-26.
6. Nakamura T., Suwa H., Nobata A. and Suzuki T. (1998) *Earthquake Response Characteristics of Base-isolated Building Using The Friction Damper With Coned Disc Springs*. Proceedings of The 10th Earthquake Engineering Symposium, Volume 3, pp.2901-2906.
7. Nakamura T., Suzuki T., Nobata A., Suwa H. and Inaba S. (1999) *Shaking Table Tests for Base-isolated Model Using the Friction Damper with Coned Disc Springs*. Journal of Structural Engineering, AIJ, No.522, pp.37-44.